

# Holosun

## PARALOW HS503C

### Circle Dot Sight

User's Manual

Solar Powered

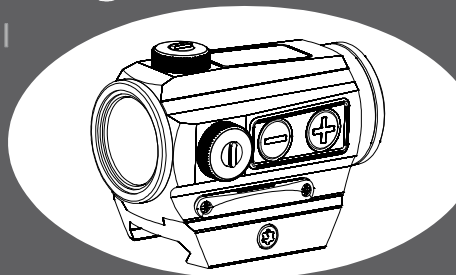

www.holosun.com

Thank you for purchasing the PARALOW HS503C Circle Dot sight. Please read the User's Manual carefully.

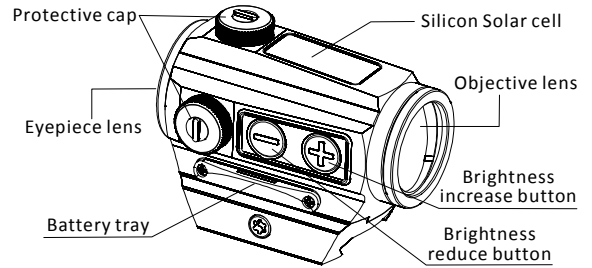

Fig1 PARALOW HS503C Circle Dot Sight

#### Features

- Weather:** Suitable for all weather conditions, including low light such as at dawn/nightfall.
- Full field of view for target acquisition:** The user can gain rapid target acquisition and situational awareness while aiming with both eyes open.
- Solar power supply:** The device operates by solar power (silicon solar cell). Power is ready for use at all times. Under daylight conditions, LED can be powered by solar cell.
- Dual power supply design:** Sight will switch to battery supply if there is not enough light for solar operation.
- New LED technology:** Due to adopting new LED technology, the sight can be operated for up to 30,000 hours with only one battery.
- Parallax free optical system:** Parallax is  $\leq \pm 1MOA$ .
- Brightness adjustment:** There are 12 settings for the brightness of the reticle so as to match the ambient lighting conditions.
- Eye safe:** LED reticle pattern will not damage your eyes.
- Two side mounted buttons:** The side mounted buttons allow for easy operation without obstructing the user's vision.
- Mounting rail type:** Picatinny or Weaver rail. Industry standard mount allows for attachment of after market mounts.
- Waterproof:** IP67

#### Multi Reticle



The reticle for this sight is a central 2MOA dot, centered in a 65MOA circle with four positioning points. The diameter of the circle reticle represents approximately 5' 5" at 100 yards. The circle reticle

can be enabled or disabled as required by pressing the "-" button for 3 seconds. The circle reticle cannot be disabled while in automatic mode.

#### Important notices

- Ensure that the firearm is completely unloaded and safe before device installation, sighting in, or installing a new battery.
- Please keep the packaging should you need to make a warranty claim.

#### Battery

- Operates with two-way power supply (solar cell and internal battery). The operating voltage for this device is DC3V using one high quality CR2032 Lithium battery included with purchase.
- The high quality battery can power the device for up to 30,000 hours. Caution: The battery is not rechargeable.

#### 3. Battery replacement :

##### 1) Removing the battery (Fig 2-1):

- Loosen screws 1,2.
- Insert coin or similar object in the battery tray slot, pry out the battery tray, and remove the discharged battery by lifting it up. A tool is provided for this purpose.

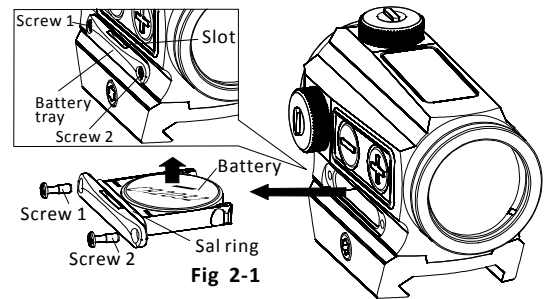

Fig 2-1

##### 2) Battery installation(Fig2-2):

- Insert the battery into the battery tray by pushing it down with the correctly marked polarities, "+" and "-".
- Insert and press the tray into the battery compartment.
- Tighten screws 1,2.

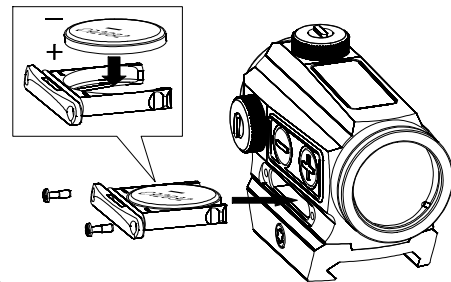

Fig 2-2

#### Caution:

The loss or damage of seal ring will cause the water leaking into compartment and may damage electronic circuits and the device.

#### Installation

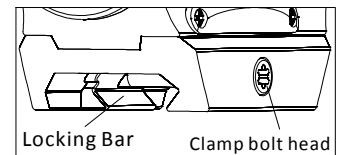

Fig 3

- The mounting bracket is adaptable to any firearm with a Picatinny Rail. If the firearm has no Picatinny rail, or compatible rail, contact a qualified gunsmith to install one.
- Insert the appropriate Torx wrench (included) into the clamp screw head, rotate to loosen the cross bolt and then slide the sight into the firearm rail to the appropriate position. Finally tighten the clamp screw. (Fig3)

## Sight operation

Two operation modes are available: Auto mode and manual mode.

1. **Auto mode (default)** - with solar cell and internal battery two-way power supply:

Based upon the ambient lighting level, the sight will switch between battery and solar cell power automatically for operation in all lighting conditions.

Auto mode operation:

- Sight is always in auto mode unless specifically switched to manual mode.
- While in auto mode, the brightness of the reticle is automatically adjusted to match ambient lighting. The brighter it is, the higher the dot intensity.
- If lighting is low enough, the sight will automatically switch to the battery. While running on battery, you can adjust the reticle brightness using the "+" and "-" buttons to switch between levels 3, 4, or 5.

2. **Manual Mode** (Internal battery power only mode):

- Press down the "+" button for 3 seconds to enter into Manual Mode.
- Brightness adjustment: There are 12 settings for reticle brightness level under manual mode. The default brightness is at 7 when the device is switched to this mode. The brightness can be adjusted as required by pressing the "+" or "-" to increase or decrease the brightness level, one press for one change in brightness level.
- Switching back to auto mode: Simultaneously press the "+" and "-" buttons to switch to auto mode. The device will also switch automatically from manual mode to auto mode if there has been no other button operation in 12 hours.

**Note:** In summary, the sight is always ready for use, no matter what the lighting conditions are.

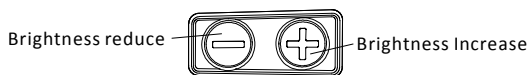

Fig 4

## Zero setting

- On top of sight is the elevation adjusting knob, windage adjusting knob is on the right side (see Fig5). The sight has been factory adjusted for approximate zero.
- The built in screw driver tool on the protective cap can be used for zeroing adjustment (see Fig5). See label inside cap.
- First open the protective cap (see Fig1), position slot type screwdriver on the slotted screw, then rotate the screw to right or left for adjustment. Each left or right click is for one adjustment equivalent to 0.5MOA value.

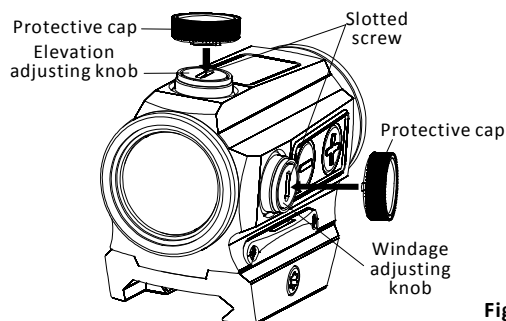

Fig 5

- Rotating the elevation knob right will moving the red dot up, left turning will lower the red dot. Similarly for the windage adjustment, rotating right will move the red dot to right, left turning will move it to left.

5. Caution:

Don't try to over rotate the knobs. If you feel the knobs cannot be rotated, this indicates you have reached the adjustment limit, otherwise the device may be damaged. If the required adjusting range is beyond the limits, consider adding an extra spacer between the device and mounting rail to allow for additional adjustment.

## Maintenance and care

This device is a precision instrument that deserves reasonably cautious care. The following tips are provided to ensure long lasting use of the sight.

The optical system, including the objective window and eyepiece lens are multi-coated optical glass. When cleaning the lenses, blow away the dust on surface, wet the lens with lens cleaner or clean water, wiping the fingerprint or other oils with lens tissue, soft cotton or microfiber cloth. No special maintenance is needed for the housing surface. Avoid touching the glass surface with dry cloth or tissue paper. Do not use organic solvents such as alcohol or acetone. Do not try to dismantle the device as the internal parts are specially cleaned and sealed and with an anti-fog treatment. Any such attempt will void the warranty.

If repair is needed, you can call our customer service center, visit our website, or send an email to us.

## Limited warranty

### SUMMARY

We provide a limited lifetime warranty from the date of purchase on parts and workmanship to the original purchaser. At our sole discretion, we will repair or replace product found to be defective under normal use and service without charge, excluding any delivery costs, which will be born by purchaser.

We will not be liable for incidental, consequential, or special damages arising out of or in any connection with the use or performance of this product. This warranty is void if the product has been misused, modified, neglected, or disassembled prior to its return.

Please refer to <http://www.holosun.com> for current and complete warranty information and other conditions.

PARALOW HS503C  
**Circle Dot sight**



### Customer Service

Phone: 954-880-4823  
Email: [info@holosun.com](mailto:info@holosun.com)

**HOLOSUN**  
Holosun Technologies Inc.  
[www.holosun.com](http://www.holosun.com)